

# LINEAR FIXTURE TRACK - SPOT SPEC SHEET



LFT60-S



The LFT60-S Series is a range of spotlight solution ideal for galleries or focus lighting on specific subject or wall. With its wide range of track mounting options, the LFT60-S are compatible with recessed, surface and suspended pendant mounting. The series is equipped with dimming and standard color temperature of 3000K. With the versatility of 355-degree rotation and 90-degree tilt angle, the LFT60-S Series can direct its light to almost any direction. The LFT60-S3-2 in particular has two light engines with a power rating of 50 Watts and has three beam angles options.



LFT60-S3-2

## SPECIFICATIONS

<b>OPERATING VOLTAGE</b>	120 VAC
<b>RATED POWER</b>	50W
<b>CONTROL</b>	0/1-10 V Dimmable
<b>FLUX</b>	2829 lm x2
<b>CRI</b>	>90
<b>BODY FINISH</b>	Black, White
<b>BAFFLE FINISH</b>	Black, White, Copper
<b>MOUNTING</b>	Track mounted
<b>PROJECTION</b>	17°, 25°, 35°
<b>ROTATION</b>	355°
<b>TILT ANGLE</b>	90°

<b>V</b>	<b>120 VAC</b> Operating Voltage
<b>W</b>	<b>50W</b> Rated Power

## DIMENSIONS

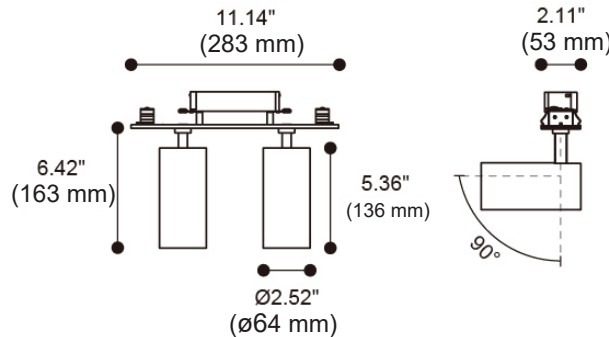

## ORDERING CODE

SERIES	TYPE	POWER	VOLTAGE	CRI	COLOR TEMPERATURE	PROJECTION	TRACK MOUNTING	BODY FINISH	BAFFLE FINISH
LFT60	S3-2 - Spot 3-2	50W - 50 WATTS	AC - 120VAC	90 - CRI90	CT30 - 3000K	17D - 17 Degrees	RM - Recessed Mount	BK - Black	BK - Black
					CTXX - CUSTOM	25D - 25 Degrees	SM - Surface Mount	WH - White	WH - White
						35D - 35 Degrees	PM - Pendant Mount		CO - Copper

ACCESSORIES		
S17-1	-	Long Snoot
ACSG-8	-	Striped Glass
ACHO-11	-	Honeycomb Louver
ACWG-9	-	Woven Glass

Sample: LFT 60-S3-2 - 50W- AC - 90 - CT30 - 17D - SM - BK - CO - ACHO-11

# LINEAR FIXTURE TRACK - MOUNTING & ACCESSORIES

LFT60-S

## MOUNTING OPTIONS

### TRIMLESS: LFT-T-11

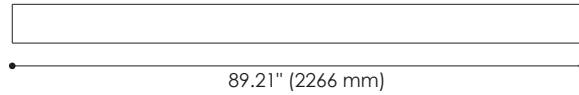
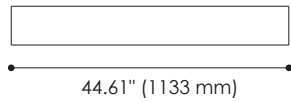
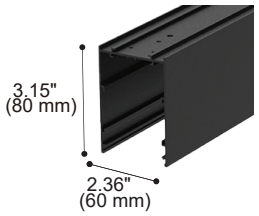

TRIMLESS TRACK SECTION	
Article number	TYPE
LFT-T-11-44	Channel
LFT-T-11-89	Channel

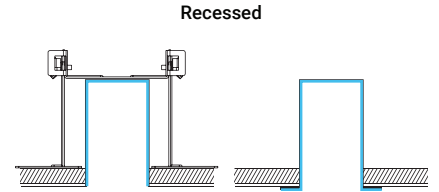

### TRIM: LFT-F-11

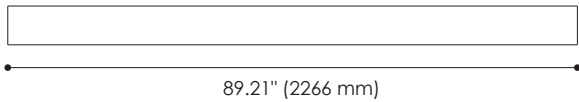
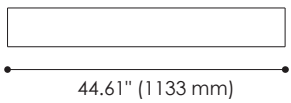
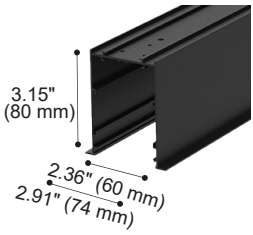

TRIMMED TRACK SECTION	
Article number	TYPE
LFT-F-11-44	Channel
LFT-F-11-89	Channel

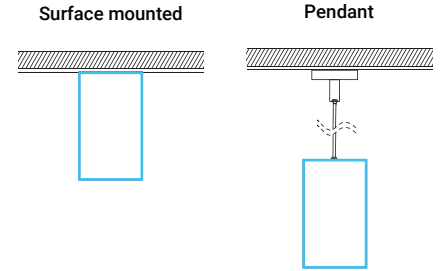

## ACCESSORIES

### ALL MODELS

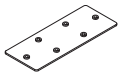
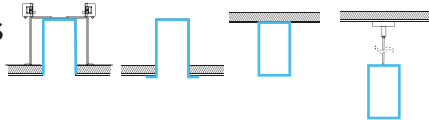

3PCS

SKU : LFT-NC-02  
Type : Surface mounted & Pendant reinforced plate

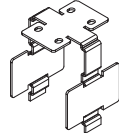

SKU : LFT-NC-07  
Type : Light Leak-proof aluminium extrusion reinforce plate



Colours  
Black White

SKU : LFT-NE-02-11 11.14\" (283 mm)  
LFT-NE-02-22 22.28\" (566 mm)  
Type : Blank cover



SKU : LFT-SA-41  
Type : Power cord connector



SKU : LFT-PA-41-180 71\" (1800 mm)  
Type : Power cord connect to AC



SKU : LFT-SA-41-30 12\" (300 mm)  
LFT-SA-41-60 24\" (600 mm)  
Type : Power cord connect between modules

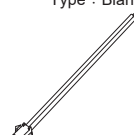

SKU : LFT-PSA-31-180 71\" (1800 mm)  
Type : Signal wire connect to system / dimmer

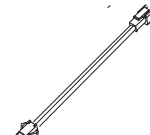

SKU : LFT-SSA-31-30 12\" (300 mm)  
LFT-SSA-31-60 24\" (600 mm)  
Type : Signal wire connect between modules

### PENDANT

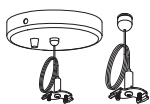
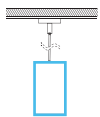

SKU : LFT-DI-15  
Type : Pendant Kit for power connection (without power cord)

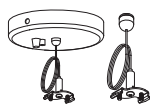

SKU : LFT-DI-15-V  
Type : Pendant Kit for power connection (without power cord and signal wire)



SKU : LFT-DI-16  
Type : Pendant kit

### TRIM

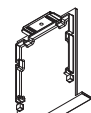
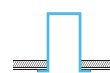

2PCS

SKU : LFT-NC-05  
Type : Trim end cap

### TRIMLESS

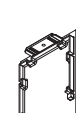
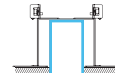

2PCS

SKU : LFT-NC-03  
Type : End cap

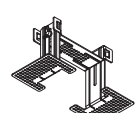

2PCS

SKU : LFT-NR-01  
Type : Trimless bracket